

RO-50

1 PORTA
1 DOOR
1 PUERTA
1 PORTE

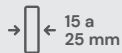

COMPONENTES/ COMPONENTS/ COMPONENTES/ COMPOSANTS

Inclusos no Kit/ Included in the Kit/ Incluidos en el Kit/ Inclus dans le Kit

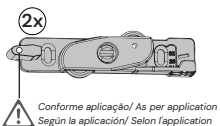
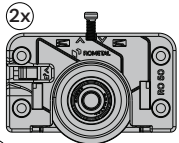

Recomendados/ Recommended/ Recomendados/ Reconnandés



3,5 x 14 CC
Carros inferiores
Bottom carriages
Carros inferiores
Chariots inférieures

3,5 x 22 CC
Guias e freios
Guides and brakes
Guías y frenos
Guides et freins

Opcionais/ Optional/ Opcionales/ Optionnels

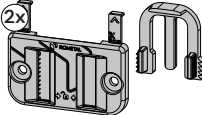

Dispositivo antidescarrilamento
Anti-derailment device
Dispositivo antidescarrilamento
Dispositif anti-déraillement

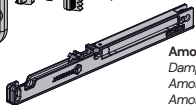

Amortecedor Comfort 240
Damper Comfort 240
Amortiguador Comfort 240
Amortisseur Comfort 240

CÁLCULO DA PORTA/ DOOR CALCULATION CÁLCULO DE LA PUERTA/ CALCUL DE LA PORTE

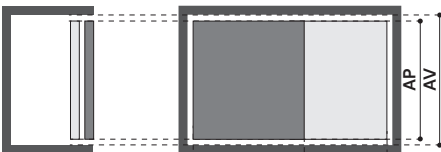

AP= AV-35 mm

Altura da porta (AP)
Door height
Altura de la puerta
Hauteur de la porte

Altura do vão (AV)
Opening height
Altura del vano
Hauteur de l'ouverture

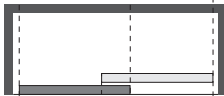

20 a 30 mm
Transpasse indicado
Recommended overlap
Solape recomendado
Recouvrement recommandé

INSTALAÇÃO/ INSTALLATION/ INSTALACIÓN/ INSTALLATION

1 Furações/ Drillings/ Perforaciones/ Perçages

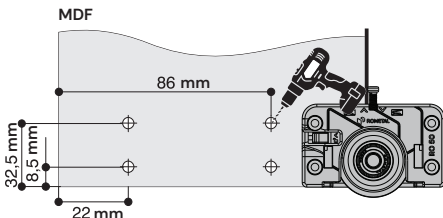

Alumínio/ Aluminium/ Aluminio/ Aluminium

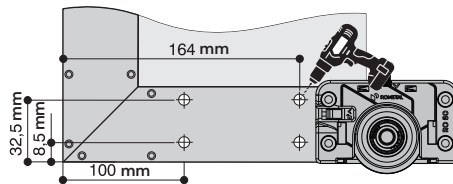

2 Instale os guias/ Install the guides Instale las guías/ Installez les guides

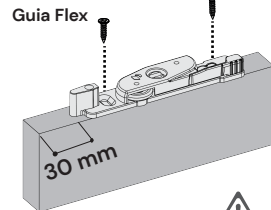

Centralize o guia na porta
Center the guide on the door
Centre la guía en la puerta
Centrez le guide sur la porte



Opções de guias
Guide options
Opciones de guías
Options de guides



Amortecedor Comfort 240
Damper Comfort 240
Amortiguador Comfort 240
Amortisseur Comfort 240

Espaçamento do trilho/ Track spacing Espaciado del riel/ Espacement du rail

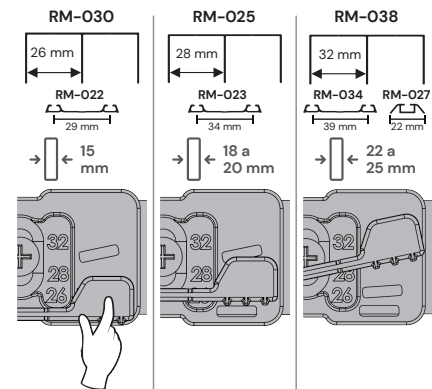

3 Fixe o antidescarrilamento Secure the anti-derailment device Fije el dispositivo de antidescarrilamiento Fixez le dispositif anti-déraillement

Com guia
With guide
Con guía
Avec guide



3,5 x 12 CF
Parafusos inclusos no kit
Screws included in the kit
Tornillos incluidos en el kit
Vis incluses dans le kit

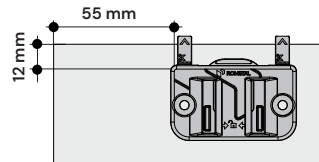

- 4 Destaque os posicionadores**
Remove the positioning guides
Retire los posicionadores
Retirez les positionneurs

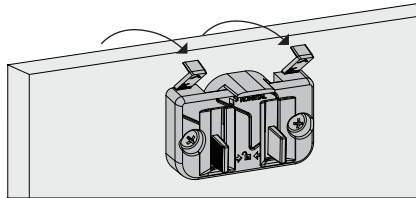

- 5 Instale os trilhos/ Install the tracks**
Fije los rieles/ Installez les rails

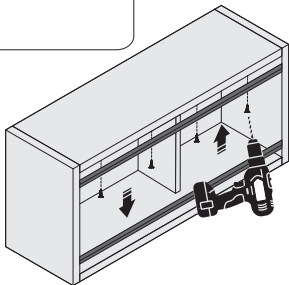
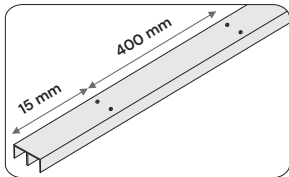

- 6 Fixe o freio no trilho superior**
Attach the brake to the top track
Fije el freno en el riel superior
Fixez le frein sur le rail supérieur

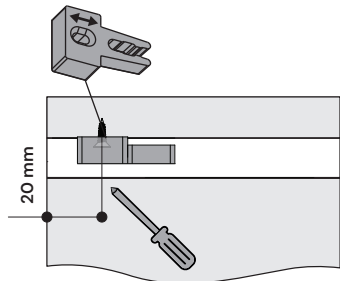

- 7 Encaixe as portas/ Fit the doors**
Encaje las puertas / Insérez les portes

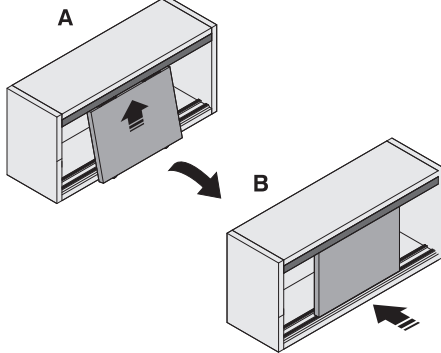

- 8 Regule as portas**
Adjust the doors
Ajuste las puertas
Ajustez les portes

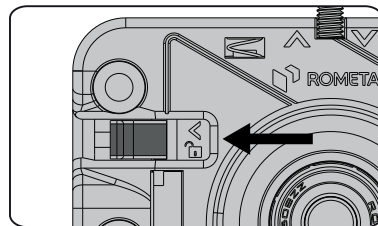

Destrave as molas
Unlock the springs
Desbloquee los muelles
Déverrouillez les ressorts

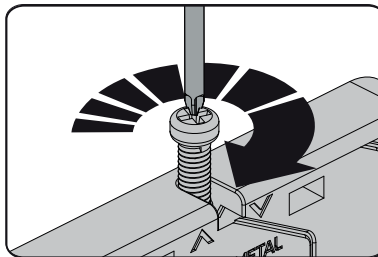

Regule a altura da porta
Adjust the door height
Ajuste de la altura de la puerta
Réglez la hauteur de la porte

- 9 Regule o antidescarrilamento**
Adjust the anti-derailment device
Ajuste el dispositivo de antidescarrilamiento
Réglez le dispositif anti-déraillement

